

Dockside Sauna 40 (229x213)

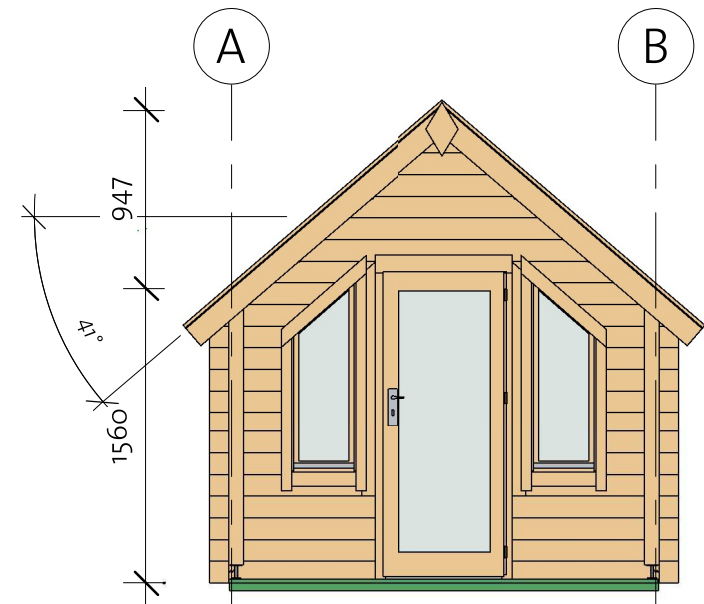

Dockside Sauna 40 (229x213)

Foundation

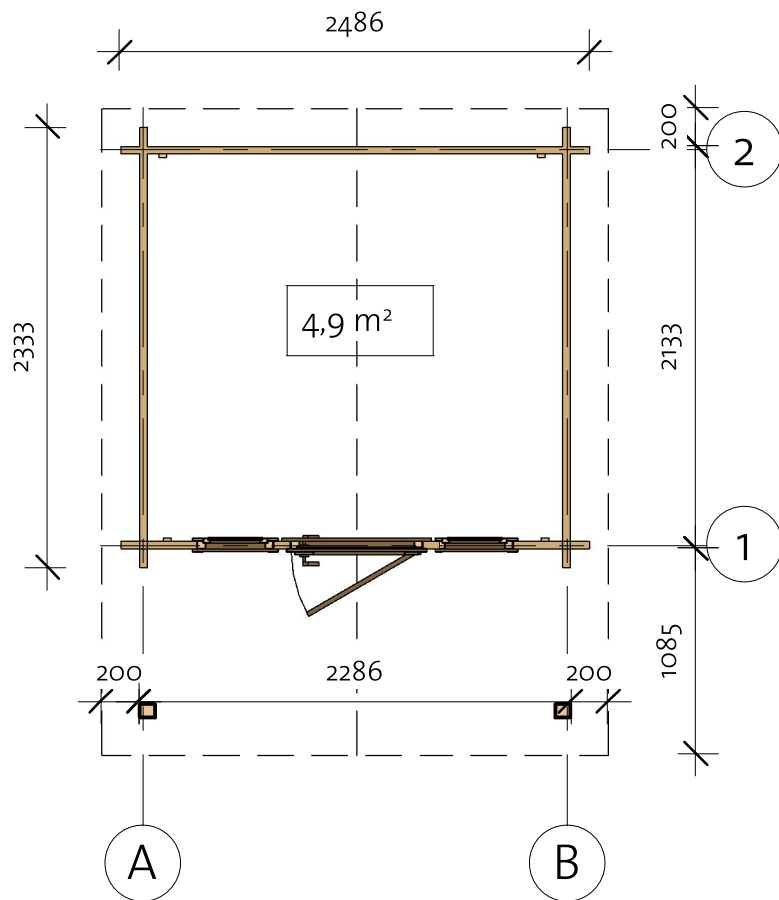
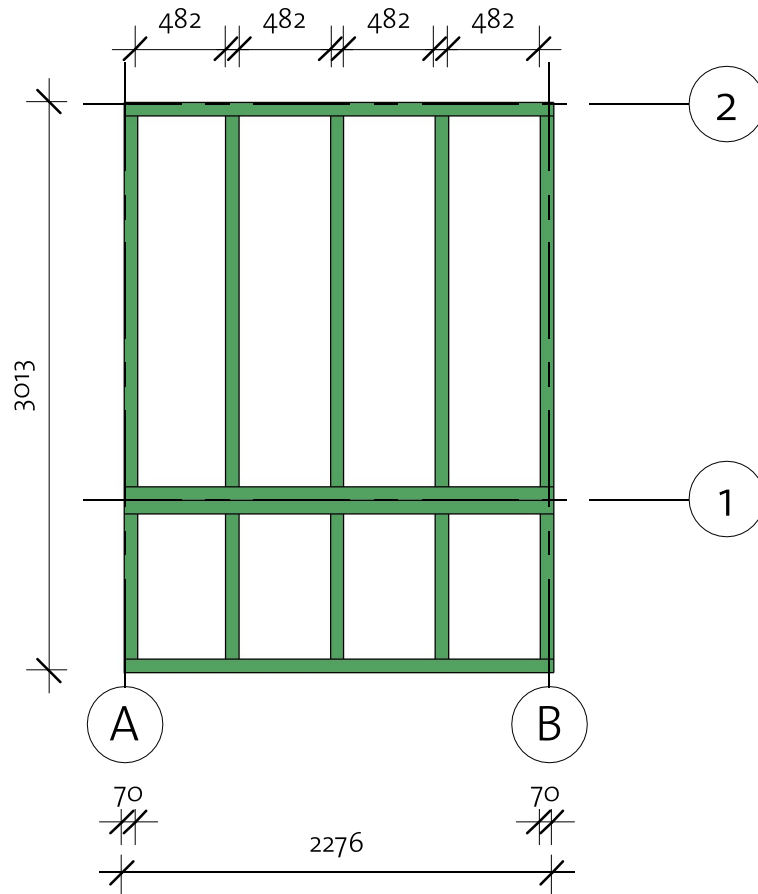

Impregnated foundation beams				
Mark	Type	Profile	Count	Length

IFB1	IFB 70x40		5	1968
IFB2	IFB 70x40		4	2276
IFB3	IFB 70x40		5	765

Dockside Sauna 40 (229x213)

Floor Plan

① Baseboard

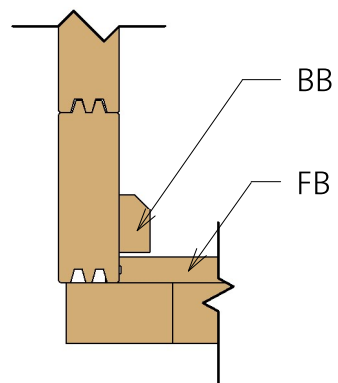



Floor Schedule

Mark	Type	Profile	Count	Length
------	------	---------	-------	--------

FB	FB 17x114		18	2200
----	-----------	---	----	------

Terrace Schedule

TB	TB 21x95		9	2276
----	----------	---	---	------

BB	BB 18x40		4	2200
----	----------	---	---	------

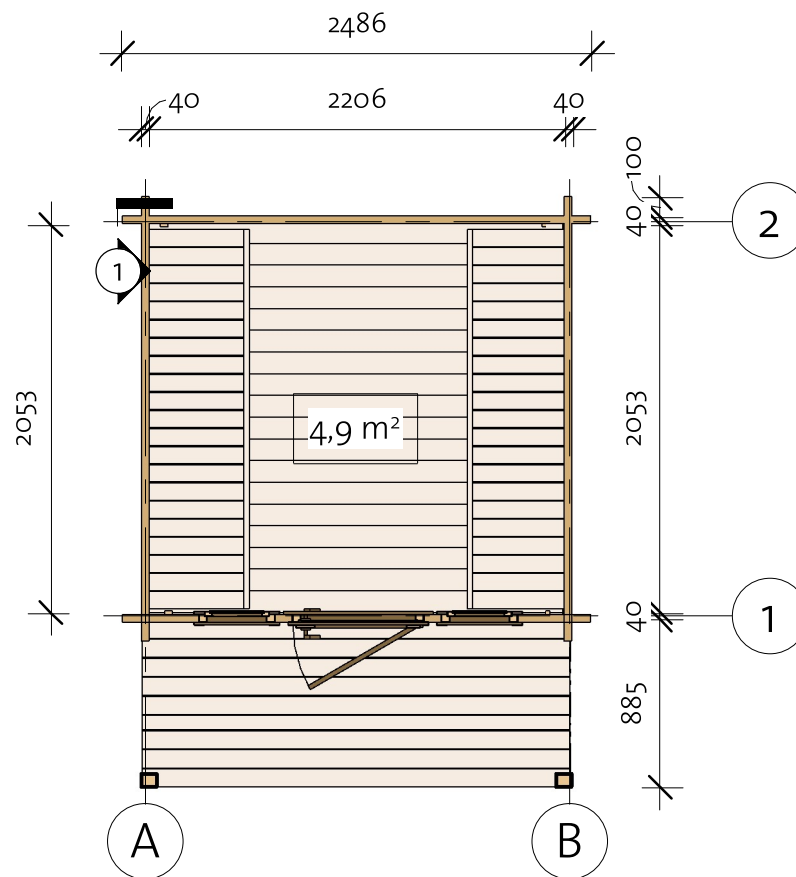

Dockside Sauna 40 (229x213)

Wall 1

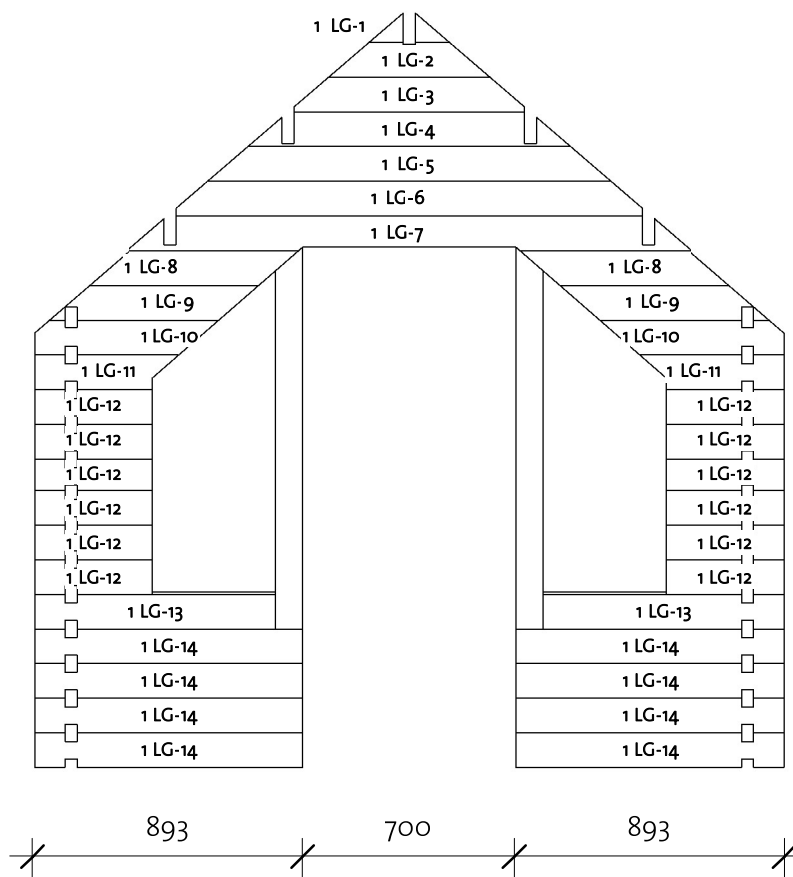
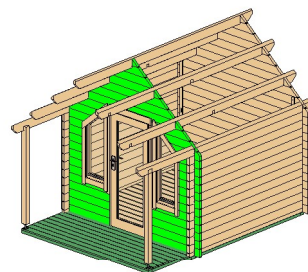

Wall 1			
Mark	Profile	Count	Cut Length

1LG-1 *	40X114	1	263
1LG-2 *	40X114	1	529
1LG-3 *	40X114	1	757
1LG-4 *	40X114	1	1060
1LG-5 *	40X114	1	1325
1LG-6 *	40X114	1	1531
1LG-7 *	40X114	1	1857
1LG-8 *	40X114	2	706
1LG-9 *	40X114	2	708
1LG-10*	40X114	2	626
1LG-11 *	40X114	2	495
1LG-12	40X114	12	398
1LG-13	40X114	2	803
1LG-14	40X114	8	893

* Gable - delivered premounted

Column schedule		
Type	Length	Count
Post 40x90	1266	2

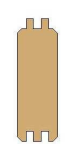
Log Profile Wall 1	
Profile	Profile
40X114	

Dockside Sauna 40 (229x213)

Wall 2

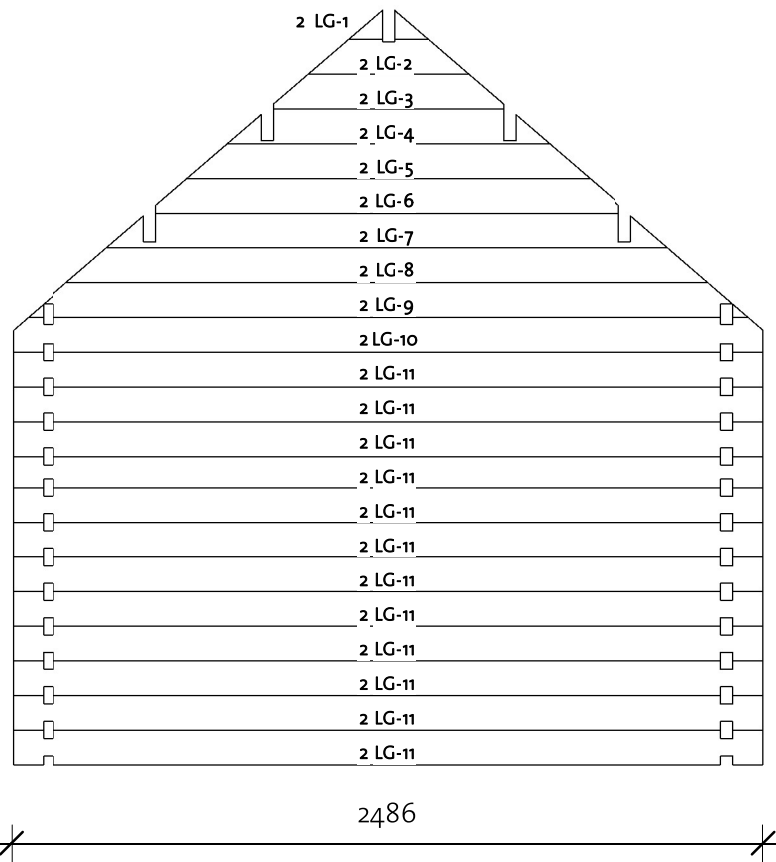
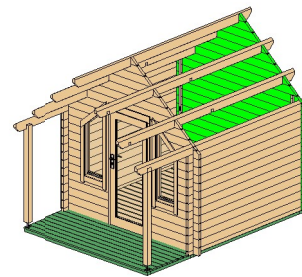

Wall 2			
Mark	Profile	Count	Cut Length

2LG-1 *	40X114	1	263
2LG-2 *	40X114	1	529
2LG-3 *	40X114	1	757
2LG-4 *	40X114	1	1060
2LG-5 *	40X114	1	1325
2LG-6 *	40X114	1	1531
2LG-7 *	40X114	1	1857
2LG-8 *	40X114	1	2122
2LG-9 *	40X114	1	2388
2LG-10 *	40X114	1	2486
2LG-11	40X114	12	2486

* Gable - delivered premounted

Log Profile Wall 2	
Profile	Profile

40X114	
--------	--

Dockside Sauna 40 (229x213)

Wall B

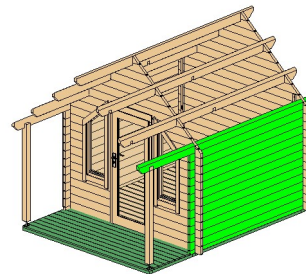

Wall B			
Mark	Profile	Count	Cut Length

BBL-1	40X57	1	2333
BLG-1	40X114	12	2333
BTL-1	40X135	1	3418

Log Profile Wall B	
Profile	Profile

40X135	
40X114	
40X57	

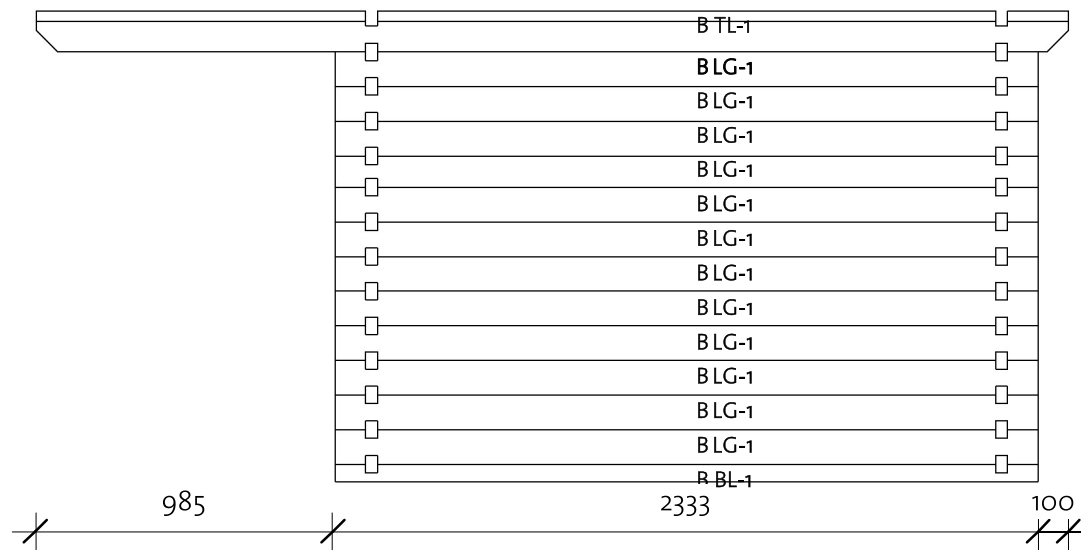



92402161_240304

Dockside Sauna 40 (229x213)

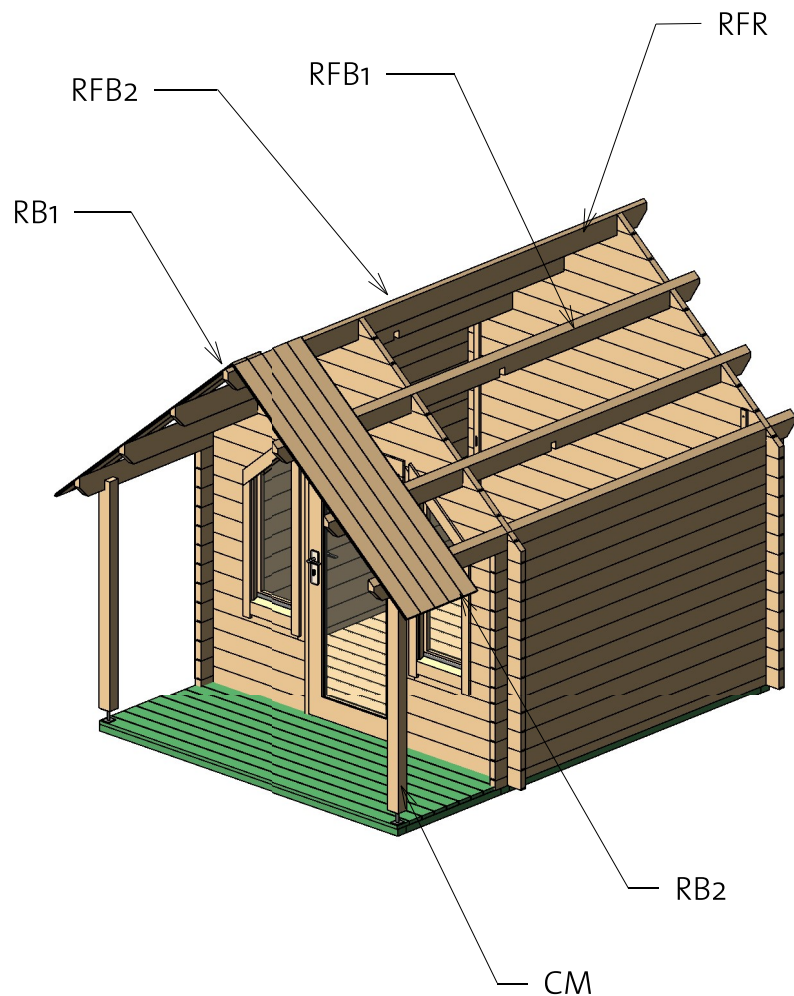
Roof 1

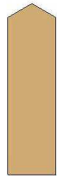

Roof				
Mark	Type	Profile	Count	Length
RB1	17x114		30	1753
RB2	17x114		30	1770
RFB1	Beam 40x143		2	3418
RFB2	Beam 40x143		2	3418
RFR	Ridge 40x143		1	3418

Columns			
Mark	Profile	Count	Length
CM	Post 80x70	2	1386

Dockside Sauna 40 (229x213)

Roof 2

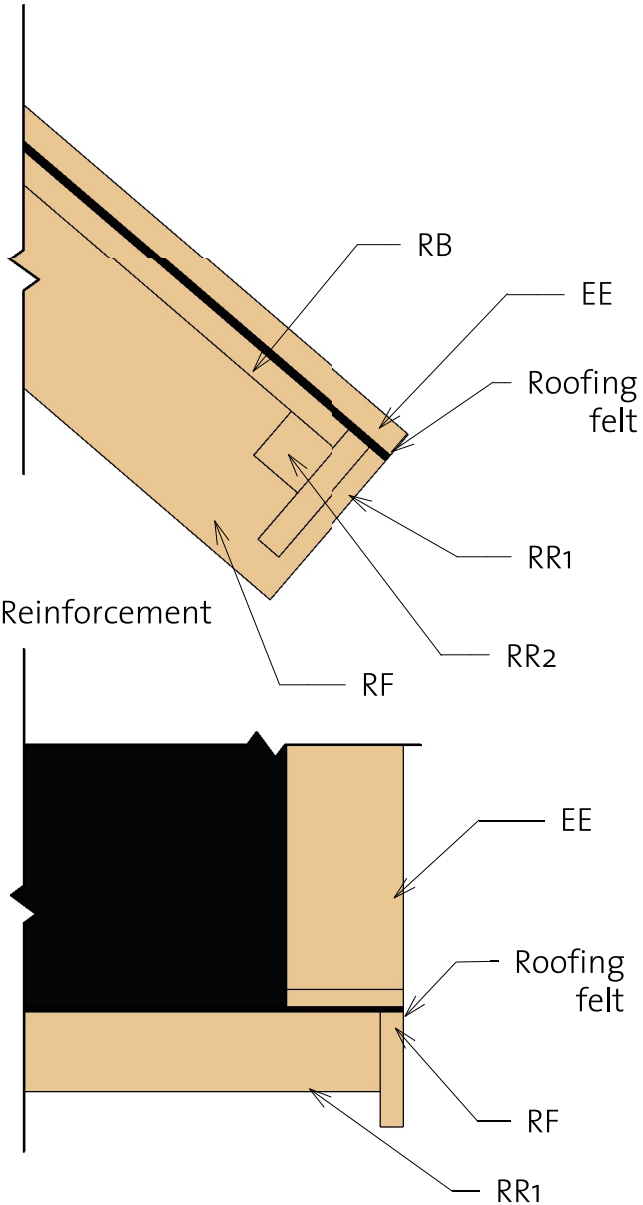
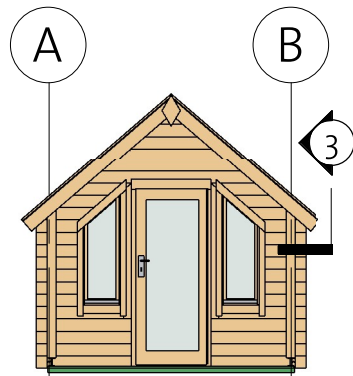
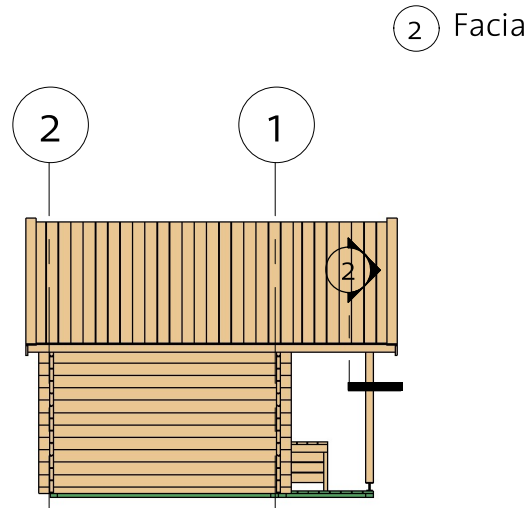

Fascia Schedule				
Mark	Type	Profile	Count	Length
EE	Eave Edging 18x95		4	1802
RF	Roof Fascia 18x120		4	1802
RR1	Roof reinforcement 18x95		2	3418
RR2	Roof reinforcement 38x38		2	3418

Dockside Sauna 40 (229x213)

Extras

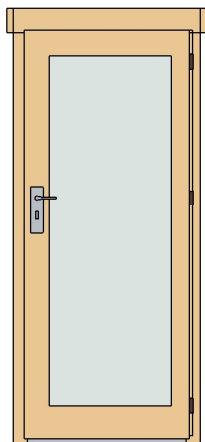

Door Schedule				
Model	Type	Width	Height	Count
CD13R	Classic door 13 right, tempered	690	1670	1

Type	Count	Length
------	-------	--------

Windboard 18x40	4	1500
--------------------	---	------

Type	Count
------	-------

Romb	2
------	---



Fasteners/Extras		
Name	Type	Count

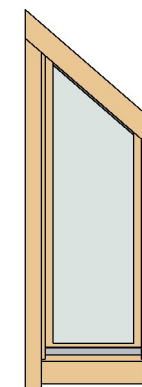
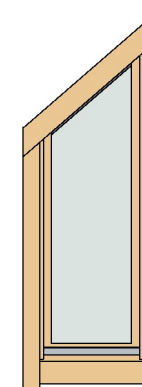

Hitblock	300-400 mm	
Adjustable post foot		2
Bolts	M8x70	12
Nails	1,4 x 40	20
Screws	5,0 x 70	35
Screws	6,0 x 140	60
Screws	4,0 x 40	840

Window Schedule				
Mark	Type	Width	Height	Count
CW23	Classic window 23, tempered	400	1026	1
CW24	Classic window 24, tempered	400	1026	1



Dockside Sauna 40 (229x213)

Sauna

Sauna				
Mark	Type	Profile	Count	Cut Length
S1	28x90		42	500
S2	28x90'		8	1990
S3	40x70		4	1990
S4	40x70		10	428

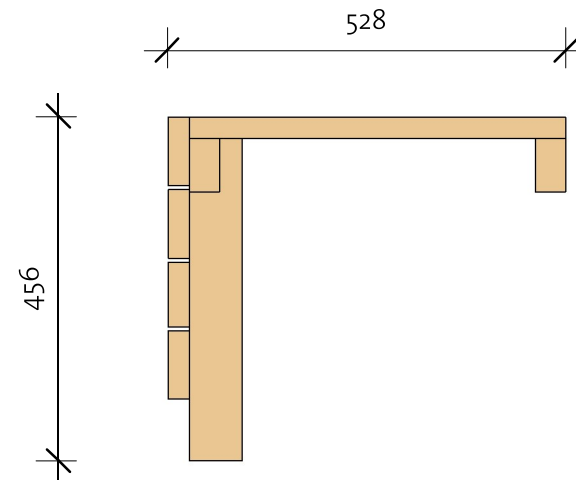
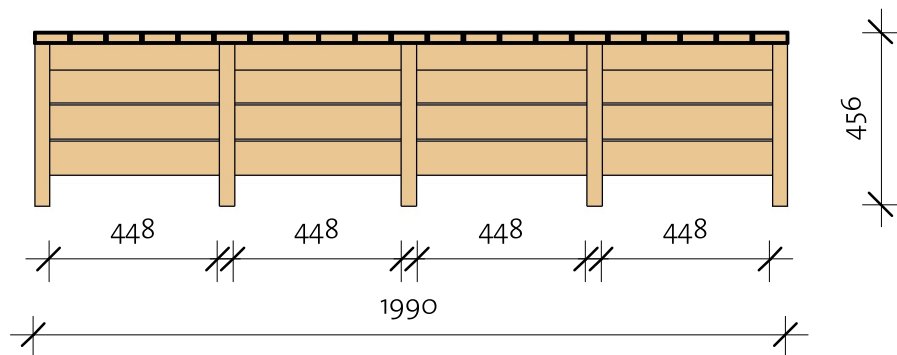



Dockside Sauna 40 (229x213)

List of all items 1

Impregnated foundation beams

Mark	Type	Profile	Count	Length
IFB1	IFB 70x40		5	1968
IFB2	IFB 70x40		4	2276
IFB3	IFB 70x40		5	765

Roof

Mark	Type	Profile	Count	Length
RB1	17x114		30	1753
RB2	17x114		30	1770
RFB1	Beam 40x143		2	3418
RFB2	Beam 40x143		2	3418
RFR	Ridge 40x143		1	3418

Floor Schedule





Mark	Type	Profile	Count	Length
FB	FB 17x114		18	2200

Terrace Schedule

TB	TB 21x95		9	2276
----	----------	---	---	------

BB	BB 18x40		4	2200
----	----------	---	---	------

Fascia Schedule

Mark	Type	Profile	Count	Length
EE	Eave Edging 18x95		4	1802
RF	Roof Fascia 18x120		4	1802
RR1	Roof reinforce ment 18x95		2	3418
RR2	Roof reinforce ment 38x38		2	3418

Dockside Sauna 40 (229x213)

List of all items 2

Wall 1			
Mark	Profile	Count	Cut Length

1LG-1 *	40X114	1	263
1LG-2 *	40X114	1	529
1LG-3 *	40X114	1	757
1LG-4 *	40X114	1	1060
1LG-5 *	40X114	1	1325
1LG-6 *	40X114	1	1531
1LG-7 *	40X114	1	1857
1LG-8 *	40X114	2	706
1LG-9 *	40X114	2	708
1LG-10*	40X114	2	626
1LG-11 *	40X114	2	495
1LG-12	40X114	12	398
1LG-13	40X114	2	803
1LG-14	40X114	8	893

Wall 2			
Mark	Profile	Count	Cut Length

2LG-1 *	40X114	1	263
2LG-2 *	40X114	1	529
2LG-3 *	40X114	1	757
2LG-4 *	40X114	1	1060
2LG-5 *	40X114	1	1325
2LG-6 *	40X114	1	1531
2LG-7 *	40X114	1	1857
2LG-8 *	40X114	1	2122
2LG-9 *	40X114	1	2388
2LG-10*	40X114	1	2486
2LG-11	40X114	12	2486

* Gable - delivered premounted

Wall A			
Mark	Profile	Count	Cut Length

ABL-1	40X57	1	2333
ALG-1	40X114	12	2333
ATL-1	40X135	1	3418





Wall B			
Mark	Profile	Count	Cut Length

BBL-1	40X57	1	2333
BLG-1	40X114	12	2333
BTL-1	40X135	1	3418

Dockside Sauna 40 (229x213)

List of all items 3

Log profiles	
Profile	Profile

40x57	
40x135	
40x135	
40x114	

Columns			
Mark	Profile	Count	Length

CM	Post 80x70	2	1386
----	------------	---	------

Column schedule		
Type	Length	Count

Post 40x90	1266	2
------------	------	---

Windboard

① Windboard Assembly 1



② Windboard Assembly 2

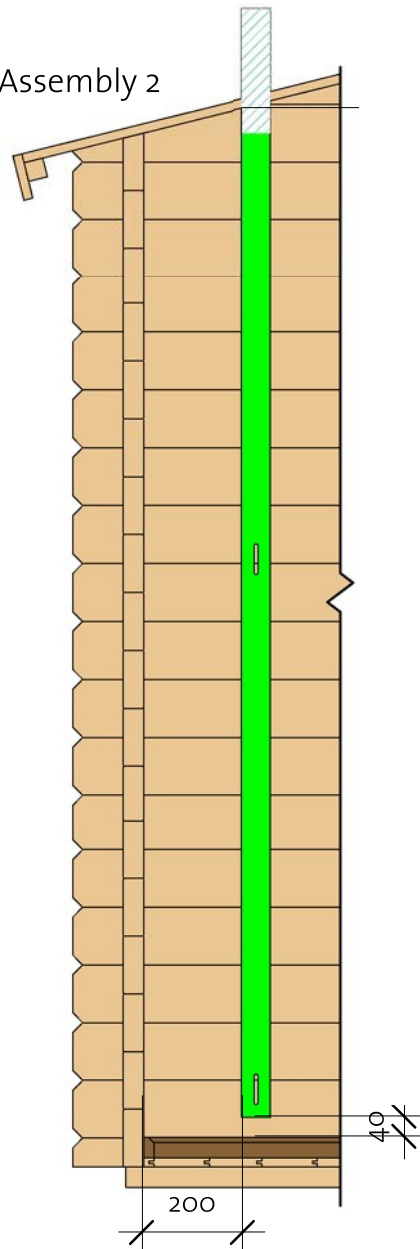

③ Windboard Assembly 3

