

Aiasaun 40 (208x208)

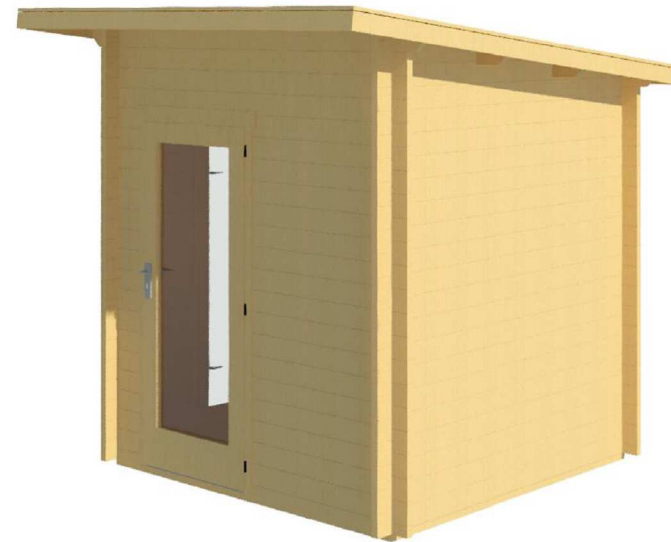

Aiasaun 40 (208x208)

Foundation

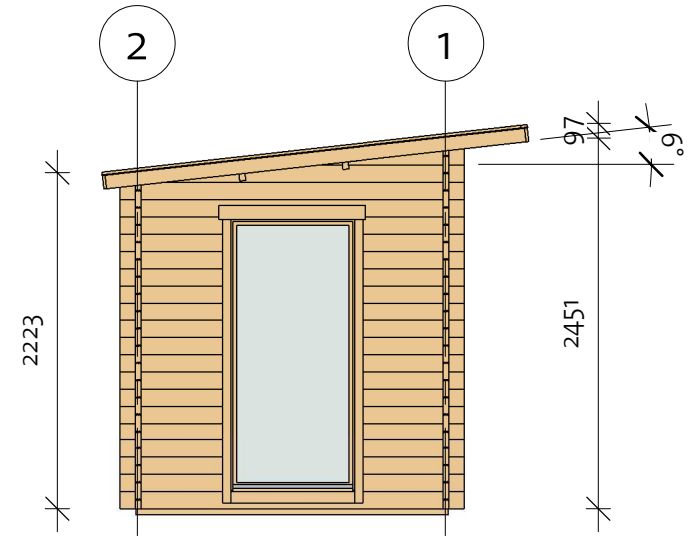
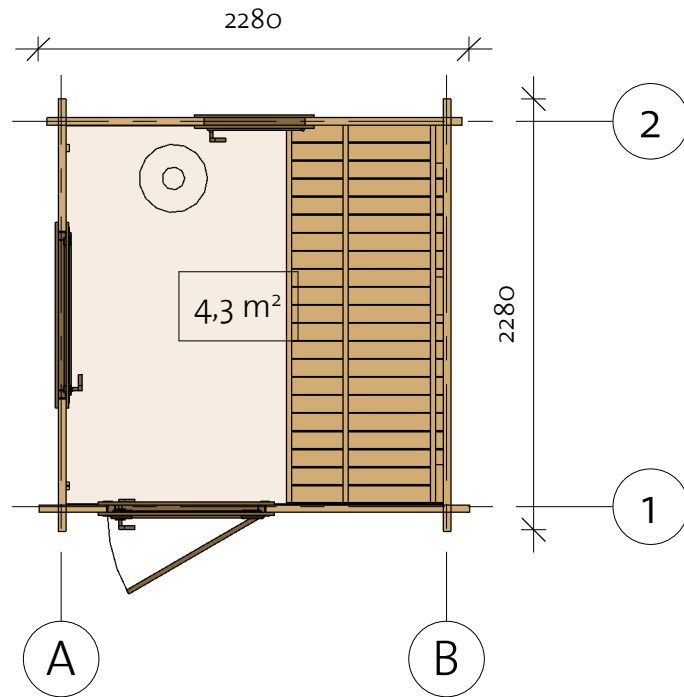
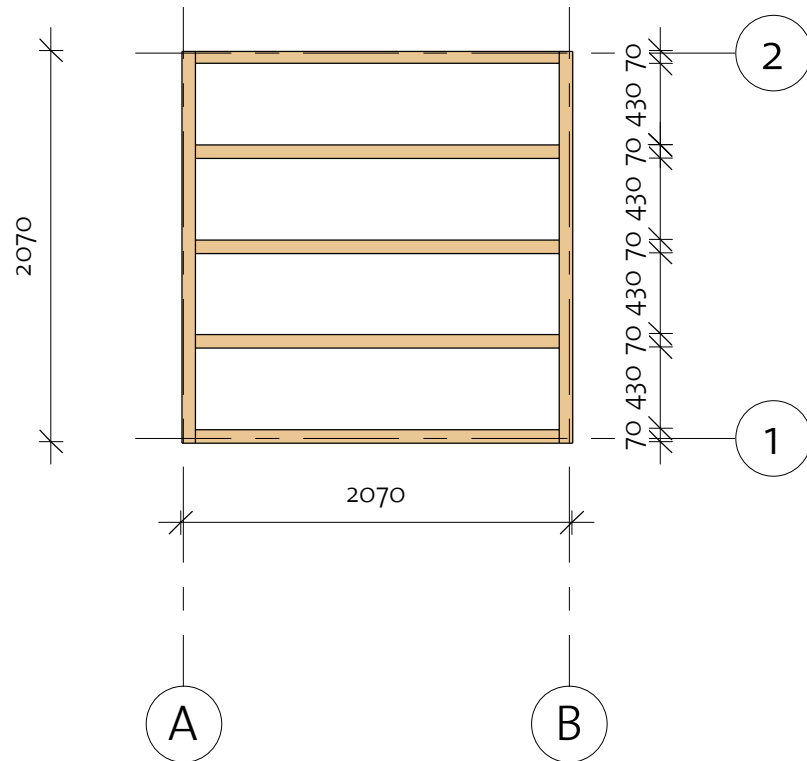

Impregnated foundation beams				
Mark	Type	Profile	Count	Length

IFB1	IFB 70x40		2	2070
IFB2	IFB 70x40		5	1930

Floor Insulation		
Type	Profile	Count

Kingspan K3	600x1200x 30	8
----------------	-----------------	---

Aiasaun 40 (208x208)

Floor Plan

① Baseboard

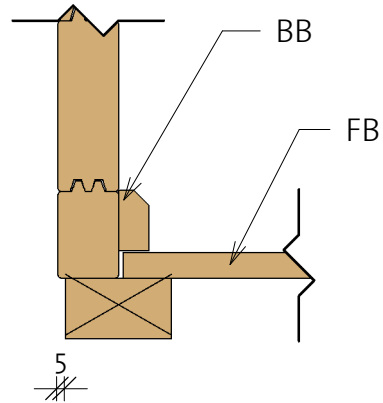

Floor Schedule

Mark	Type	Profile	Count	Length
FB	FB 17x114		18	1994
BB	BB 20x40		4	2100

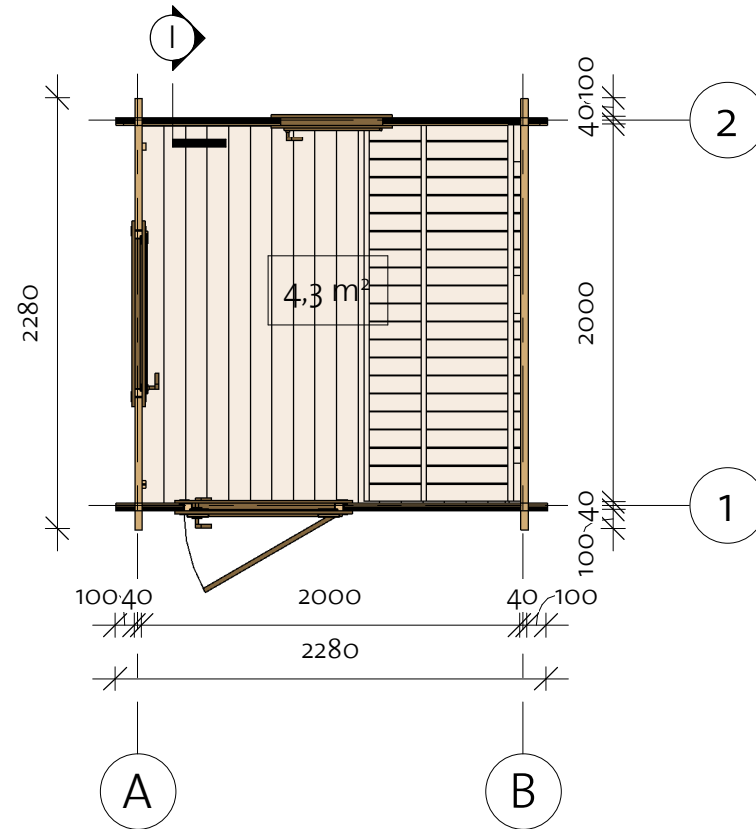

Aiasaun 40 (208x208)

Wall 2

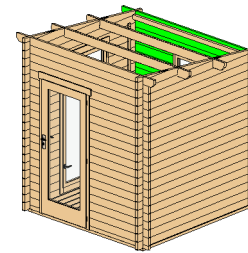

Wall 2			
Mark	Profile	Count	Cut Length

2BL-1	40x57	1	2280
2LG-1	40x114	13	2280
2LG-2	40x114	10	865
2TL-1	40x114	1	2480

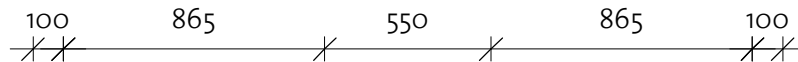
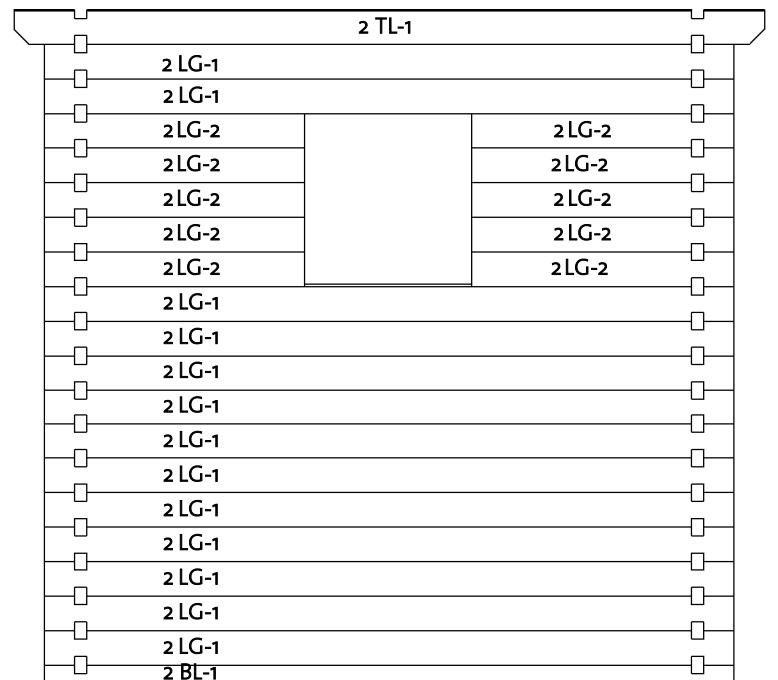

Log Profile Wall 2	
Profile	Profile

40x57	
40x114	
40x114	

Aiasaun 40 (208x208)

Wall A

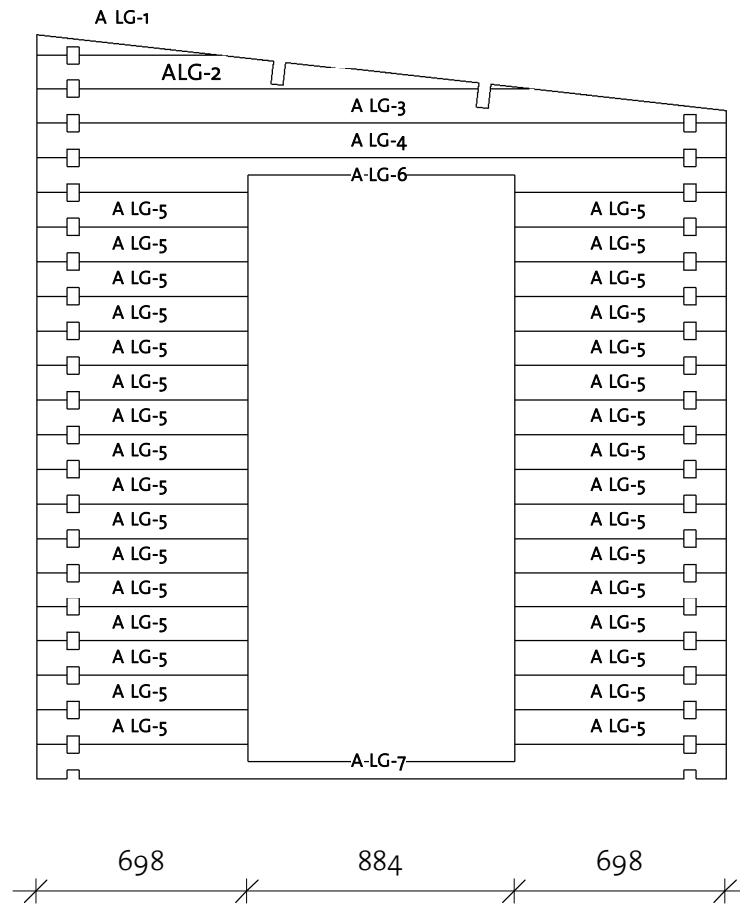
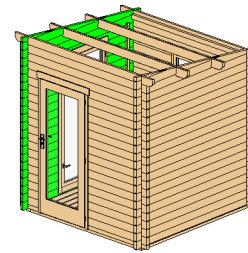

Wall A			
Mark	Profile	Count	Cut Length

ALG-1*	40x114	1	610
ALG-2*	40x114	1	1630
ALG-3*	40x114	1	2280
ALG-4	40x114	1	2280
ALG-5	40x114	32	698
ALG-6	40x114	1	2280
ALG-7	40x114	1	2280

* Gable - delivered premounted

Log Profile Wall A	
Profile	Profile

40x114	
--------	--

Aiasaun 40 (208x208)

Wall B

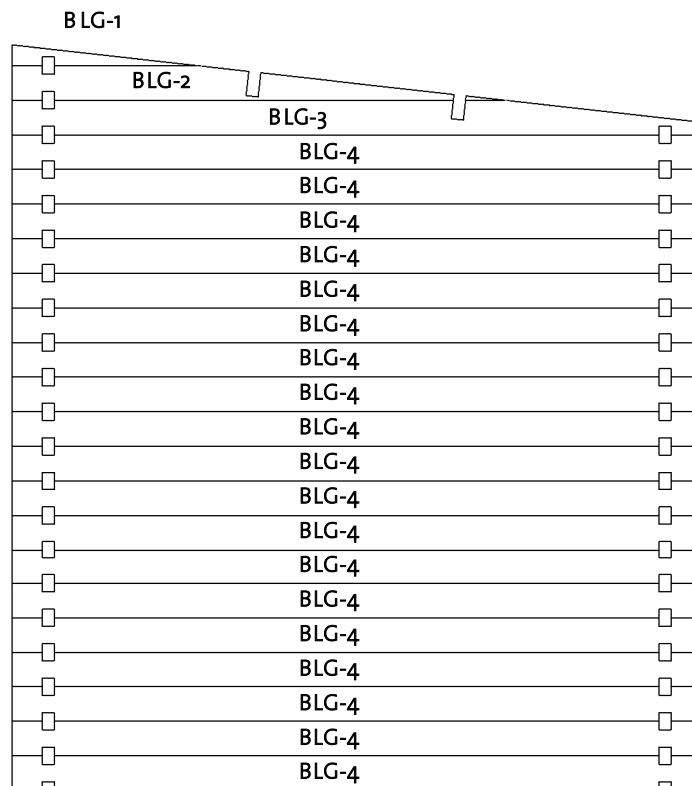
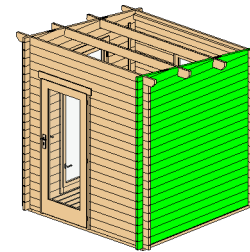

Wall B			
Mark	Profile	Count	Cut Length

BLG-1*	40x114	1	610
BLG-2*	40x114	1	1630
BLG-3*	40x114	1	2280
BLG-4	40x114	19	2280

* Gable - delivered premounted



Log Profile Wall B	
Profile	Profile

40x114	
--------	--

Aiasaun 40 (208x208)

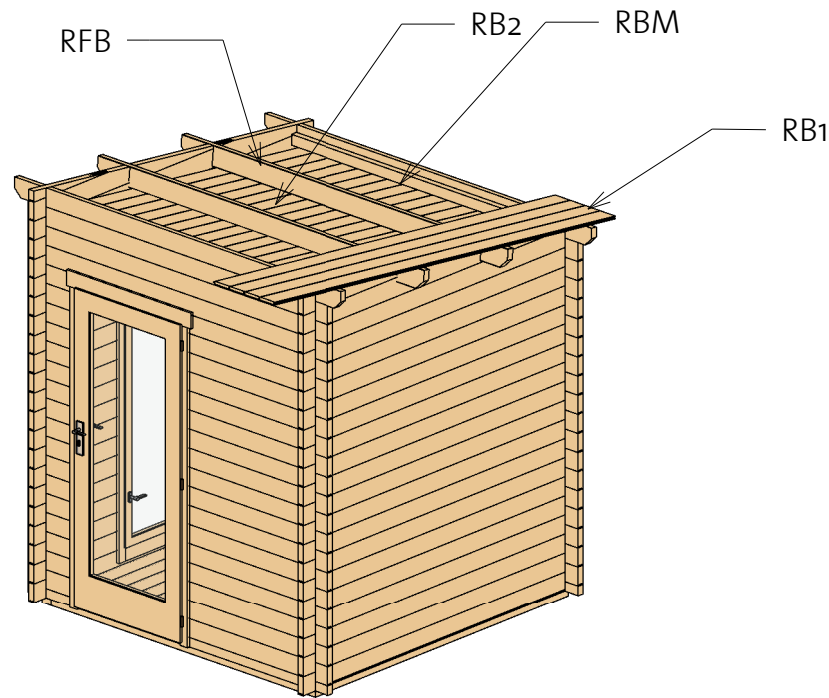
Roof 1



Roof				
Mark	Type	Profile	Count	Length
RB1	17x114		22	2795
RB2	17x114		18	2010
RBM	40x70		2	2000
RFB	Beam 40x120		2	2480

Roof Insulation		
Type	Profile	Count
Kingspan K12D	600x1200x 70	8

Aiasaun 40 (208x208)

Roof 2

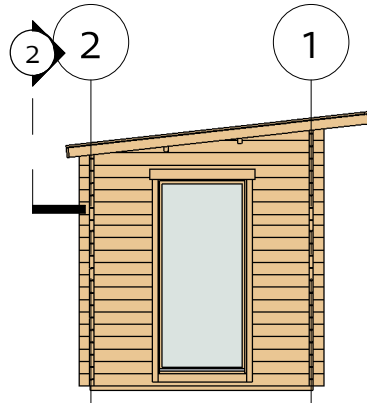

② Facia

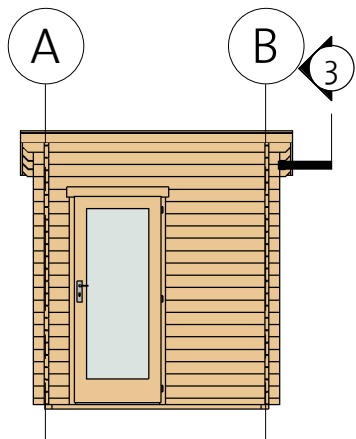
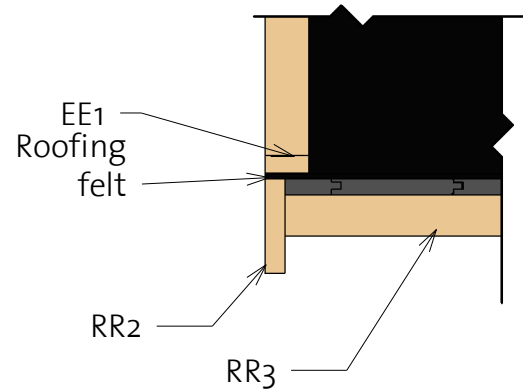

③ Roof Reinforcement

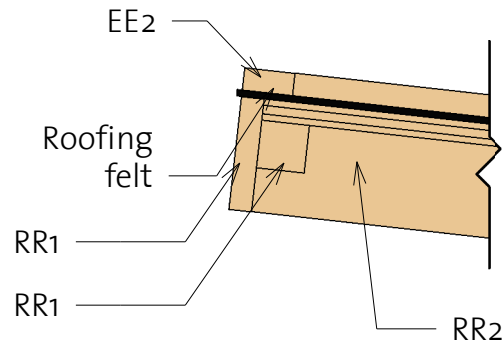

Fascia Schedule				
Mark	Type	Profile	Count	Length
EE1	Eave Edging 18x40		2	2791
EE2	Eave Edging 18x40		1	2516
RR1	Roof reinforcement 18x95		2	2516
RR2	Roof reinforcement 18x95		2	2795
RR3	Roof reinforcement 38x38		2	2480

Aiasaun 40 (208x208)

Sauna

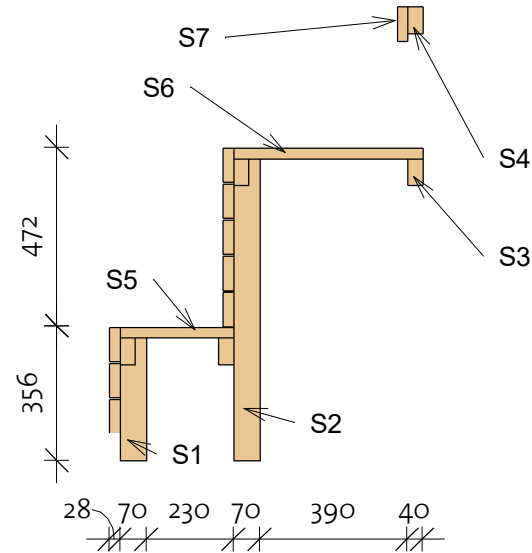
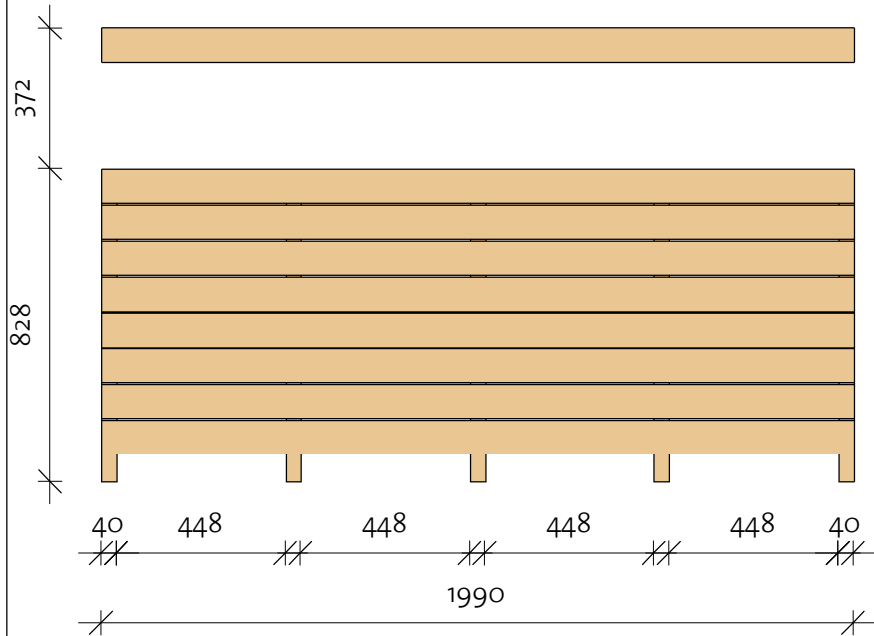

Sauna				
Mark	Type	Profile	Count	Cut Length

S1	40x70		5	328
S2	40x70		5	800
S3	40x70		3	1990
S4	40x70		3	200
S5	28x90		21	300
S6	28x90		21	500
S7	28x90		1	1990

Aiasaun 40 (208x208)

Extras

- * Windows intended for tilt opening only!
- * Fenster zur Eröffnung nur zum Kippen vorgesehen!
- * Aknad on ette nähtud ainult kaldu avamiseks!

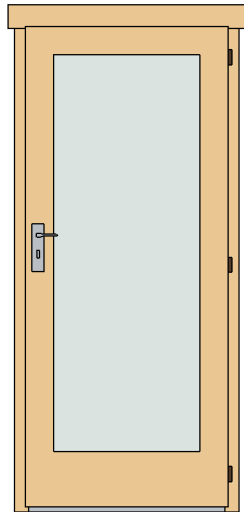

Door Schedule				
Mark	Type	Width	Height	Count

CD6R	Classic door 6 right	840	1955	1
------	-------------------------	-----	------	---

DCB8	Door Crossbar 8	--	--	1
------	--------------------	----	----	---

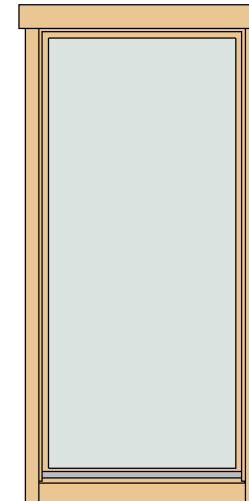

Window Schedule				
Mark	Type	Width	Height	Count

CW4R	Classic window 4, right	875	1890	1
------	-------------------------------	-----	------	---

CW12R	Classic window 12, full glass right	540	540	1
-------	--	-----	-----	---

WCB8	Windows Crossbar 8	--	--	1
------	-----------------------	----	----	---

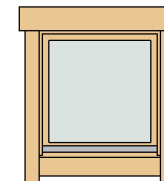

Fasteners/Extras		
Name	Type	Count

Hitblock	300-400 mm	
Bolts	M8 x 70	12
Screws	5,0 x 70	15
Nails	1,4 x 40	25
Screws	6,0 x 140	35
Screws	4,0 x 40	350

Type	Count	Length
------	-------	--------



Windboard1 18x40	2	2200
Windboard2 18x40	2	2000













92310061_240520

Aiasaun 40 (208x208)

List of all items 1

Impregnated foundation beams				
Mark	Type	Profile	Count	Length
IFB1	IFB 70x40		2	2070
IFB2	IFB 70x40		5	1930

Floor Schedule				
Mark	Type	Profile	Count	Length
FB	FB 17x114		18	1994
BB	BB 20x40		4	2100

Roof					Fascia Schedule				
Mark	Type	Profile	Count	Length	Mark	Type	Profile	Count	Length
RB1	17x114		22	2795	EE1	Eave Edging 18x40		2	2791
RB2	17x114		18	2010	EE2	Eave Edging 18x40		1	2516
RBM	40x70		2	2000	RR1	Roof reinforcement 18x95		2	2516
RFB	Beam 40x120		2	2480	RR2	Roof reinforcement 18x95		2	2795
					RR3	Roof reinforcement 38x38		2	2480

Aiasaun 40 (208x208)

List of all items 2

Wall 1			
Mark	Profile	Count	Cut Length

1BL-1	40x57	1	355
1BL-2	40x57	1	1075
1LG-1	40x114	17	355
1LG-2	40x114	17	1075
1LG-3	40x114	3	2280
1TL-1	40x114	1	2480

Wall A			
Mark	Profile	Count	Cut Length

ALG-1*	40x114	1	610
ALG-2*	40x114	1	1630
ALG-3*	40x114	1	2280
ALG-4	40x114	1	2280
ALG-5	40x114	32	698
ALG-6	40x114	1	2280
ALG-7	40x114	1	2280

Wall 2			
Mark	Profile	Count	Cut Length



2BL-1	40x57	1	2280
2LG-1	40x114	13	2280
2LG-2	40x114	10	865
2TL-1	40x114	1	2480

Wall B			
Mark	Profile	Count	Cut Length

BLG-1*	40x114	1	610
BLG-2*	40x114	1	1630
BLG-3*	40x114	1	2280
BLG-4	40x114	19	2280

* Gable - delivered premounted

Log Profiles	
Profile	Profile

40x57	
40x114	

Log Profiles	
Profile	Profile

40x114	
--------	---

Roof Insulation		
Type	Profile	Count

Kingspan K12D	600x1200x70	8
---------------	-------------	---

Floor Insulation		
Type	Profile	Count

Kingspan K3	600x1200x30	8
-------------	-------------	---

Windboard

① Windboard Assembly 1



② Windboard Assembly 2

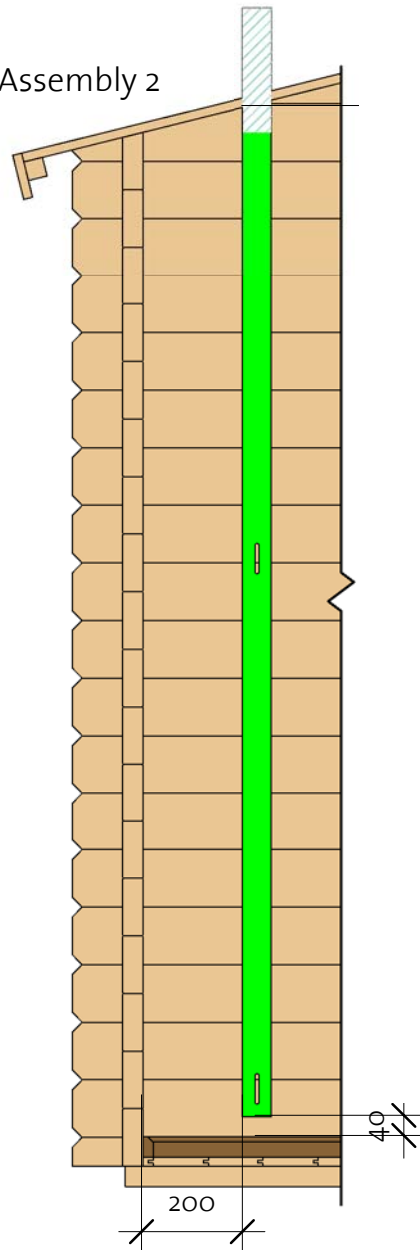

③ Windboard Assembly 3

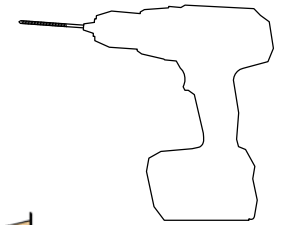
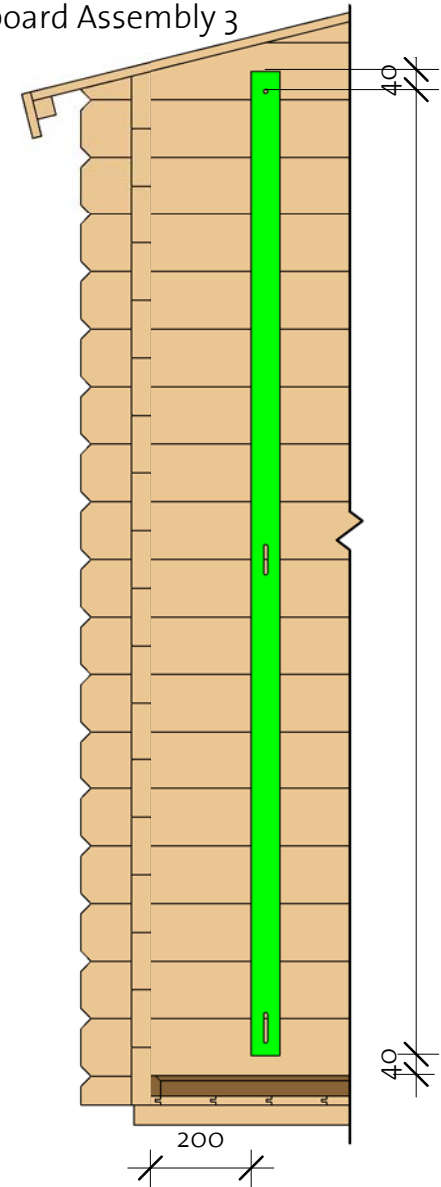

Ø 8mm