

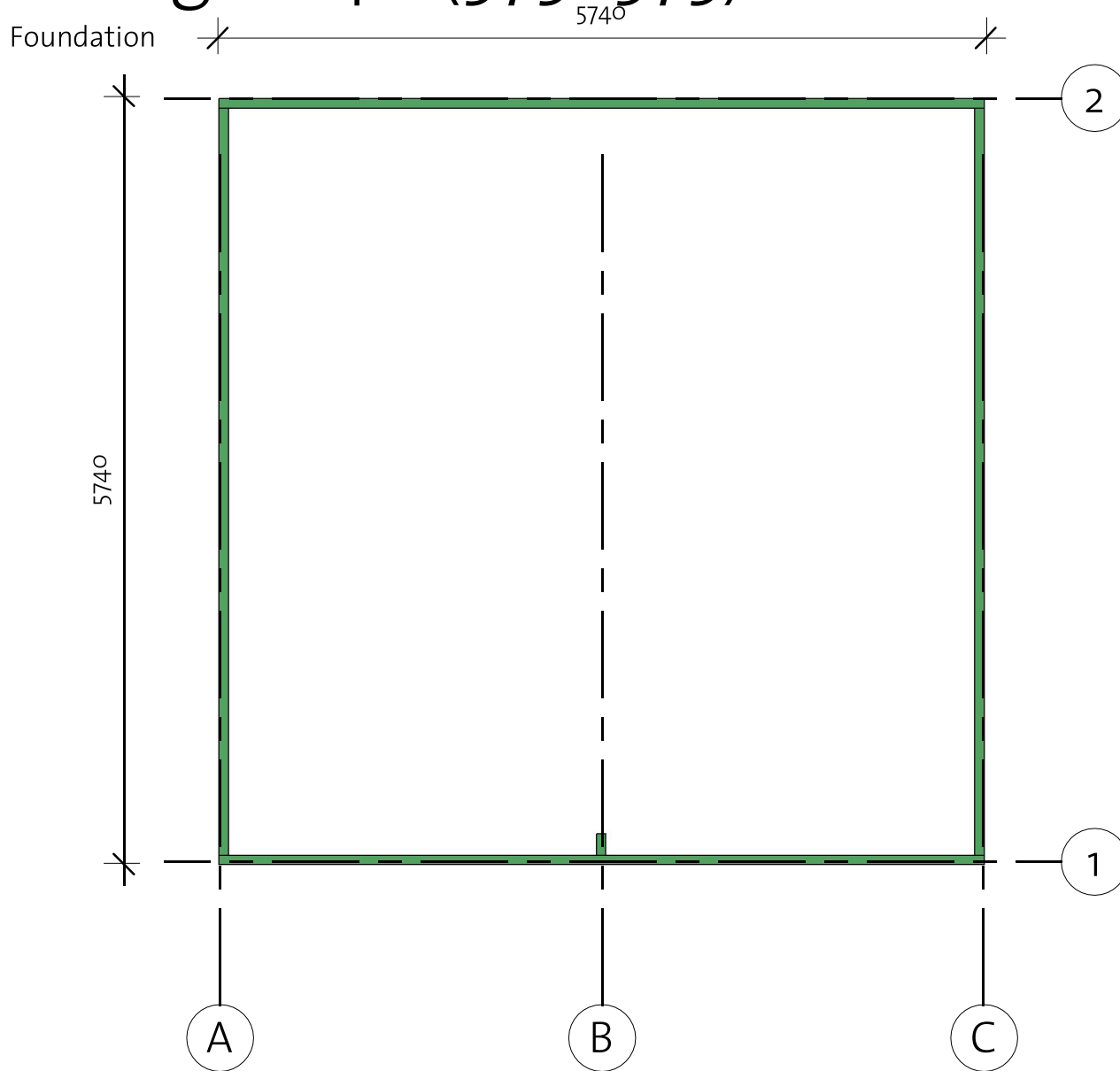



Garage E 40 (575x575)



Impregnated foundation beams

Mark	Type	Profile	Count	Length
IFB1	IFB 70x40		2	5740
IFB2	IFB 70x40		2	5600
IFB3	IFB 70x40		1	160

Garage E 40 (575x575)

Wall 1

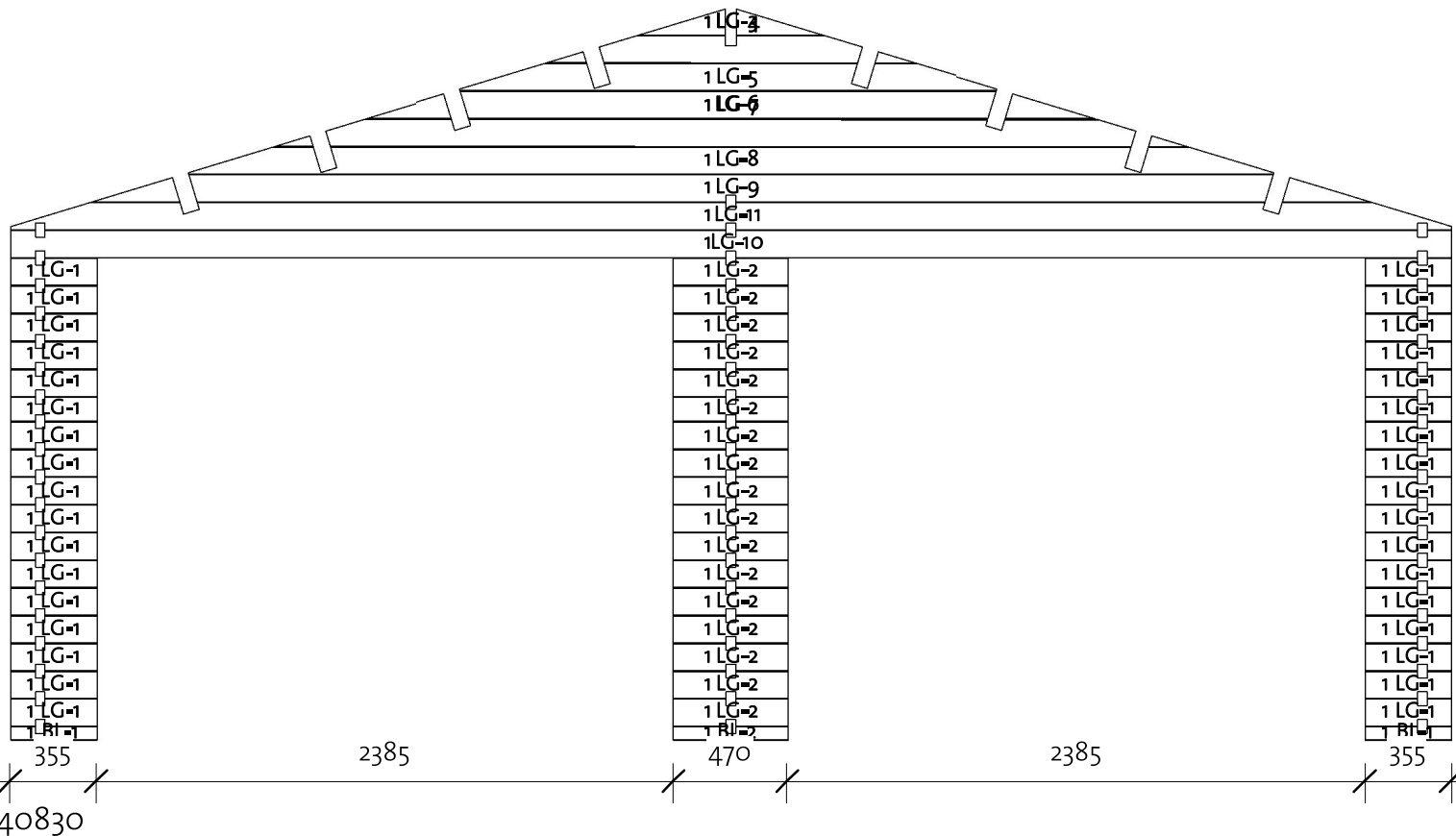
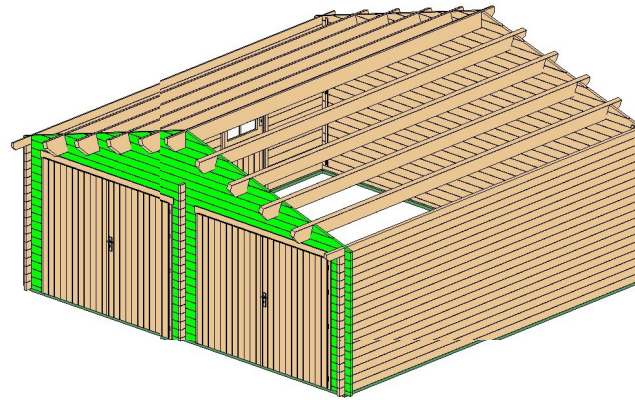

Wall 1			
Mark	Profile	Count	Cut Length

1BL-1	40x57	2	355
1BL-2	40x57	1	470
1LG-1	40x114	34	355
1LG-2	40x114	17	470
1LG-3 *	40x114	1	759
1LG-4 *	40x114	1	1517
1LG-5 *	40x114	1	2218
1LG-6 *	40x114	1	3026
1LG-7 *	40x114	1	3791
1LG-8 *	40x114	1	4491
1LG-9 *	40x114	1	5292
1LG-10	40x114	1	5950
1LG-11 *	40x114	1	5950

* Gable - delivered premounted

Log Profile Wall 1	
Profile	Profile

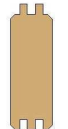
40x57	
40x114	

Garage E 40 (575x575)

Wall A

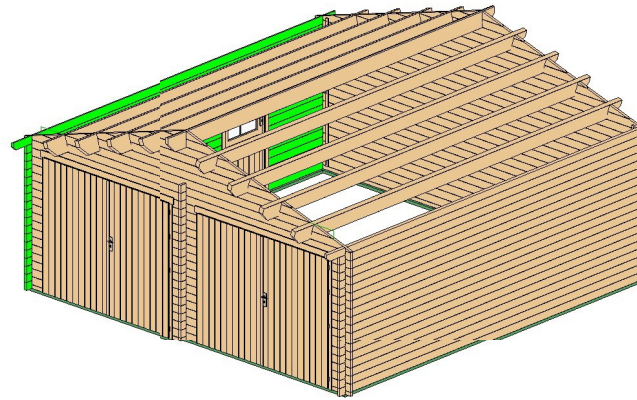

Wall A			
Mark	Profile	Count	Cut Length

ALG-1	40X114	17	1225
ALG-2	40X114	9	1098
ALG-3	40X114	9	1238
ALG-4	40X114	8	3875
ALG-5	40X114	1	5950
ATL-1	40X114	1	6300

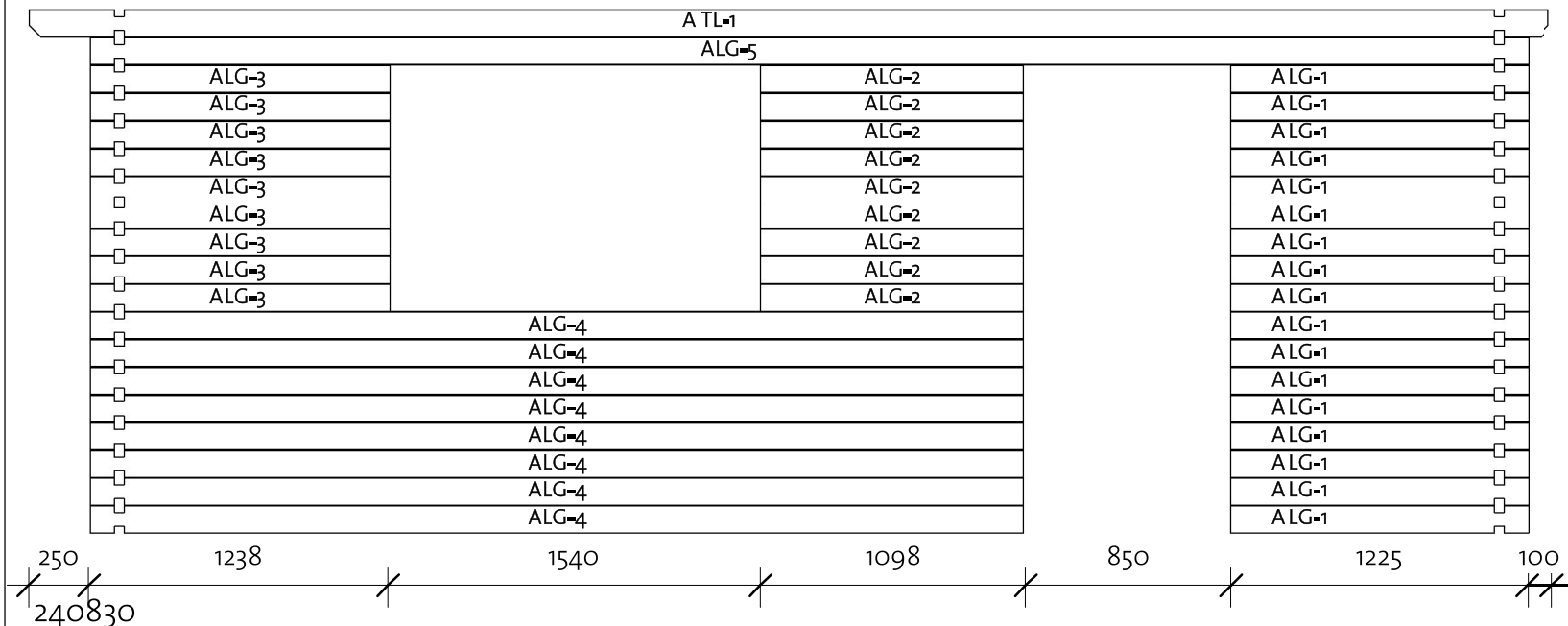





Log Profile Wall A	
Profile	Profile

40X114	
40X114	

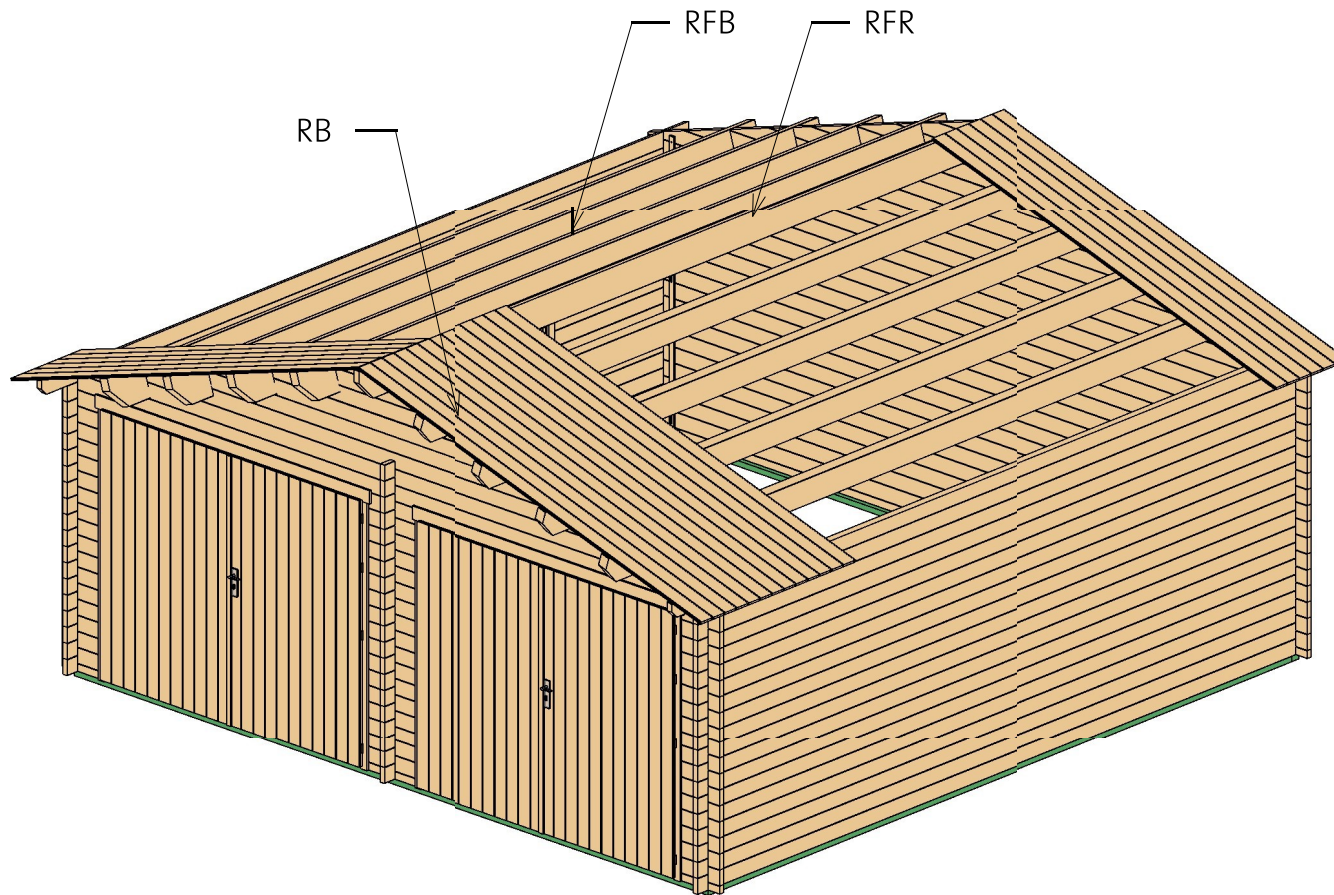
Garage E 40 (575x575)

Roof 1



Roof				
Mark	Type	Profile	Count	Length
RFR	Ridge 68x235		1	6300
RFB	Beam 68x235		8	6300
RB	17x114		102	3259

Garage E 40 (575x575)

Roof 2



2) Facia

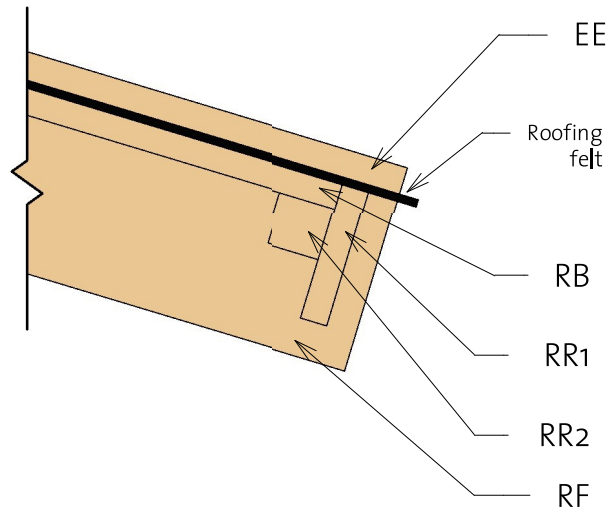

Fascia Schedule				
Mark	Type	Profile	Count	Length

EE	Eave Edging 18x95		4	3302
RF	Roof Fascia 18x120		4	3302
RR1	Roof reinforcement 18x95		2	6300
RR2	Roof reinforcement 38x38		2	6300

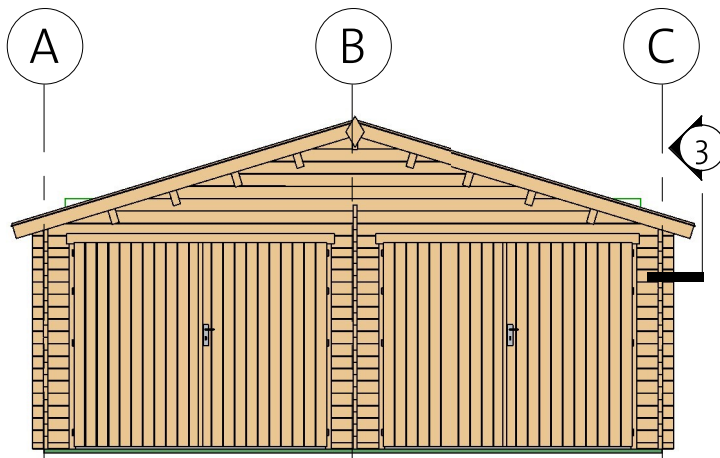

3) Roof Reinforcement

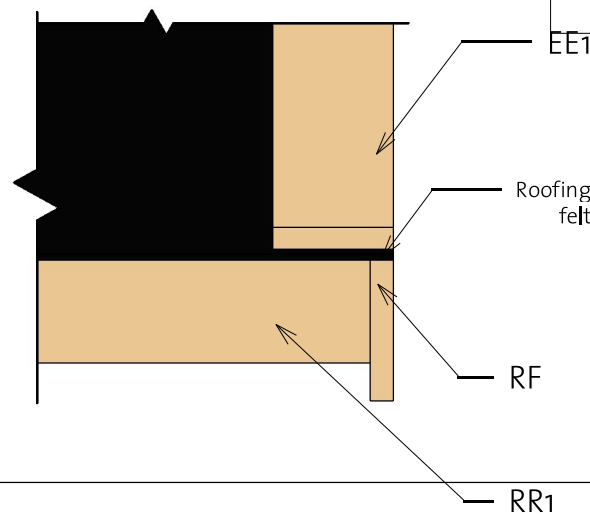

Garage E 40 (575x575)

Extras

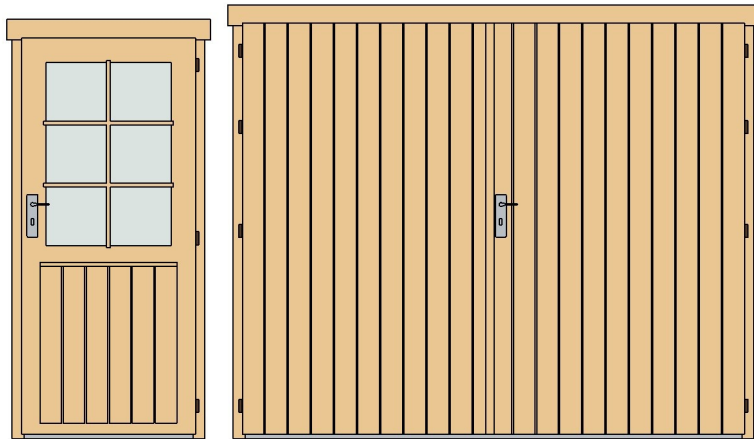

CD1R	Classic door 1 right	840	1890	1
CDD10R	Classic double door 10, wood right	2370	1955	2

DCB6	Door Crossbar 6	--	--	1
------	--------------------	----	----	---

CDW1	Classic double window 1	1530	990	1
------	----------------------------	------	-----	---

WCB6	Windows Crossbar 6	-	-	2
------	-----------------------	---	---	---

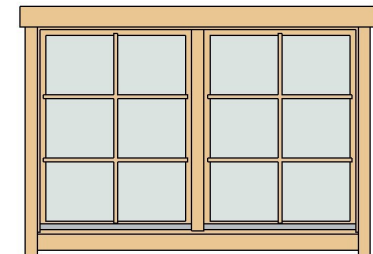

Fasteners/Extras		
Name	Type	Count

Hitblock	300-400 mm	
Door bolt	315 x 65	4
Screws	5,0 x 70	15
Bolts	M8x70	15
Screws	5,0 x 40	32
Screws	6,0 x 140	63
Screws	4,0 x 40	780

Type	Count	Length
------	-------	--------

Windboard 18x40	5	2200
--------------------	---	------

Type	Count
------	-------

Romb	2
------	---





240830





Garage E 40 (575x575)

List of all items 1



Impregnated foundation beams

Mark	Type	Profile	Count	Length
IFB1	IFB 70x40		2	5740
IFB2	IFB 70x40		2	5600
IFB3	IFB 70x40		1	160

Fascia Schedule

Mark	Type	Profile	Count	Length
EE	Eave Edging 18x95		4	3302
RF	Roof Fascia 18x120		4	3302
RR1	Roof reinforc ement 18x95		2	6300
RR2	Roof reinforc ement 38x38		2	6300

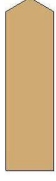
Roof

Mark	Type	Profile	Count	Length
RFR	Ridge 68x235		1	6300
RFB	Beam 68x235		8	6300
RB	17x114		102	3259

Garage E 40 (575x575)

List of all items 2

Wall 1			
Mark	Profile	Count	Cut Length

1BL-1	40X57	2	355
1BL-2	40X57	1	470
1LG-1	40X114	34	355
1LG-2	40X114	17	470
1LG-3 *	40X114	1	759
1LG-4 *	40X114	1	1517
1LG-5 *	40X114	1	2218
1LG-6 *	40X114	1	3026
1LG-7 *	40X114	1	3791
1LG-8 *	40X114	1	4491
1LG-9 *	40X114	1	5292
1LG-10	40X114	1	5950
1LG-11 *	40X114	1	5950

Wall A			
Mark	Profile	Count	Cut Length

ALG-1	40X114	17	1225
ALG-2	40X114	9	1098
ALG-3	40X114	9	1238
ALG-4	40X114	8	3875
ALG-5	40X114	1	5950
ATL-1	40X114	1	6300

Wall 2			
Mark	Profile	Count	Cut Length

2BL-1	40X57	1	5950
2LG-1 *	40X114	1	759
2LG-2 *	40X114	1	1517
2LG-3 *	40X114	1	2218
2LG-4 *	40X114	1	3026
2LG-5 *	40X114	1	3791
2LG-6 *	40X114	1	4491
2LG-7 *	40X114	1	5292
2LG-8	40X114	18	5950
2LG-9 *	40X114	1	5950

* Gable - delivered premounted

Wall B			
Mark	Profile	Count	Cut Length

BLG-1	40X114	19	350
BLG-2	40X114	1	350

Wall C			
Mark	Profile	Count	Cut Length

CLG-1	40X114	18	5950
CTL-1	40X114	1	6300

Log profiles	
Profile	Profile



Log profiles	
Profile	Profile

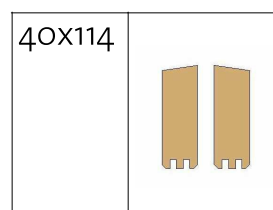

Log profiles	
Profile	Profile

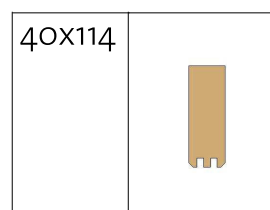

Log profiles	
Profile	Profile

